

SACAGAWEA
DESIGNS

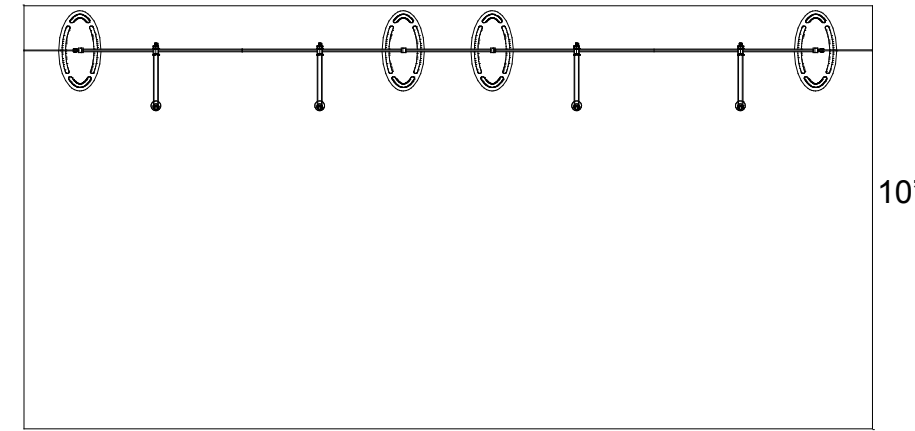

Plan View

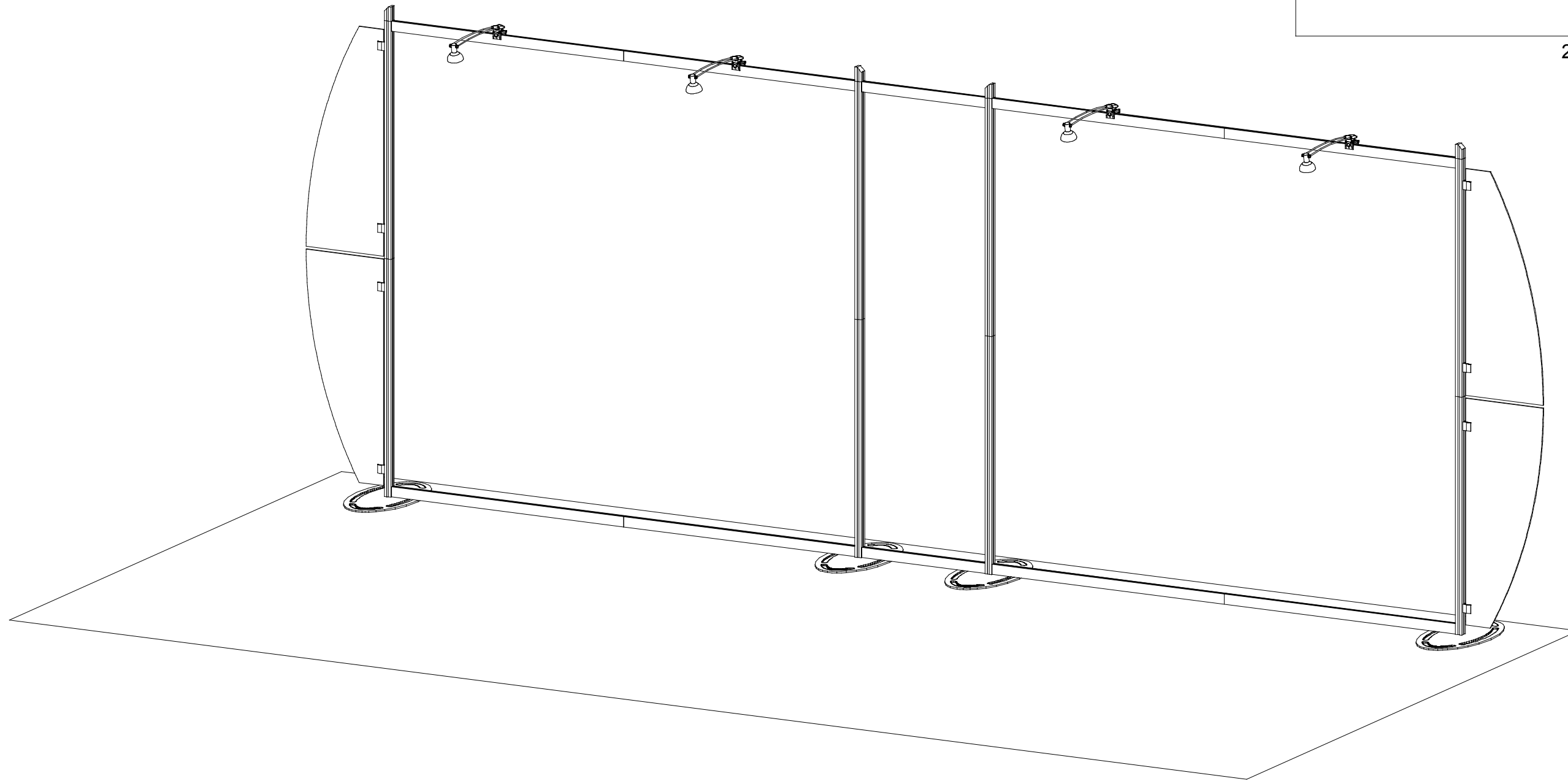

WHEN DISASSEMBLING ALUMINUM EXTRUSION, TIGHTEN ALL SETSCREWS AND LOCKS TO PREVENT LOSS DURING SHIPPING

SACAGAWEA DESIGNS

Using Your Set-up Instructions:

The Visionary Designs Set-up Instructions for Sacagawea displays are created specifically for your configuration. They are laid out sequentially, including an exploded view of the entire display and a logical series of detailed steps for assembly. We encourage you to study the instructions **before** attempting to assemble your exhibit.

THIS IS VERY IMPORTANT!

Each page reminds you to tighten the setscrews after disassembling your exhibit to prevent loss of the locks and setscrews (see below in red).

Cleaning & Packing Your Display:

- 1) Use care when cleaning aluminum extrusions or acrylic inserts. Use only non-abrasive cleaners.
- 2) When cleaning laminate inserts or counter tops, use mild cleansers and a soft material such as cotton.
- 3) Keep all display components away from extreme heat and long exposure to sunlight to avoid warping and fading.
- 4) Retain all packing materials. It will make re-packing much easier and will reduce the likelihood of shipping damage.

Hex Key Tool



Most visionary design exhibits can be assembled with the supplied Hex Key Tool. Occasionally, a flat head screwdriver may be required.

Typical Connection



Detail A: Most horizontal extrusion connections have a patented expandable lock. This lock inserts into the groove of an opposing extrusion. Tightening the lock with the Hex Key Tool expands the lock and creates a strong positive connection.

Typical Connection

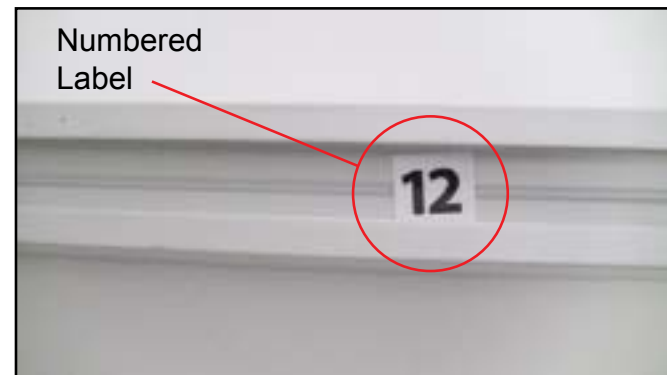

Detail B: Each extrusion contains a numbered label that corresponds to set-up instructions. The label is located within a groove of the extrusion (when possible). Visionary Design labels contain Black numbers unless otherwise specified.

Horizontal Connection



Detail C: A rectangular connection bar with plastic T Knobs is inserted between two horizontal extrusions joined end-to-end. Turn the knobs clockwise to tighten. Do Not Overtighten.

Base Plate Connection



Detail D: Attach vertical extrusions to base plates with supplied bolts inserted through the hole in the plate. Be careful not to strip the thread.

Vertical Connection



Detail E: A square connection bar with plastic T Knobs is inserted between two vertical extrusions joined end-to-end. Turn the knobs clockwise to tighten. Do Not Overtighten.

Corner Connection



Detail F: Plastic Star Knobs are used to tighten locks where horizontal extrusions connect with vertical extrusions. Turn the knobs clockwise to tighten. Turn counter-clockwise to loosen, but do not remove knob. Do Not Overtighten.

WHEN DISASSEMBLING ALUMINUM EXTRUSION, TIGHTEN ALL SETSCREWS AND LOCKS TO PREVENT LOSS DURING SHIPPING

866.652.2100

Steps:

- 1) Attach base plates [1] to lower verticals [2a,3a,2c,3c] with bolts.
- 2) Connect upper verticals [2b,3b,2d,3d] to lower verticals [2a,3a,2c,3c] with connection bars [b].
- 3) Connect horizontals [4a,4b] and [5a,5b] with connection bars [a].
- 4) Connect vertical assemblies [2a/2b,3a/3b,2c/2d,3c/3d] with horizontal assemblies [4a/4b,5a/5b] and horizontals [4c,5c] as shown.
- 5) Connect angled verticals [6a,6b] to upper verticals as shown.
- 6) Attach graphics to **velcro** on back side of frame.

Item	Qty.	Description
1	4	Base Plate
2a/2b	1/1	42" Vertical Extrusion w/ A10 Clamps
3a/3b	1/1	42" Vertical Extrusion
2c/2d	1/1	42" Vertical Extrusion
3c/3d	1/1	42" Vertical Extrusion w/ A10 Clamps
4a/4b	1/1	45" Horizontal Extrusion
5a/5b	1/1	45" Horizontal Extrusion
4c/5c	1/1	24" Horizontal Extrusion
6a/6b	1/1	2.5" Angle-Cut Vertical

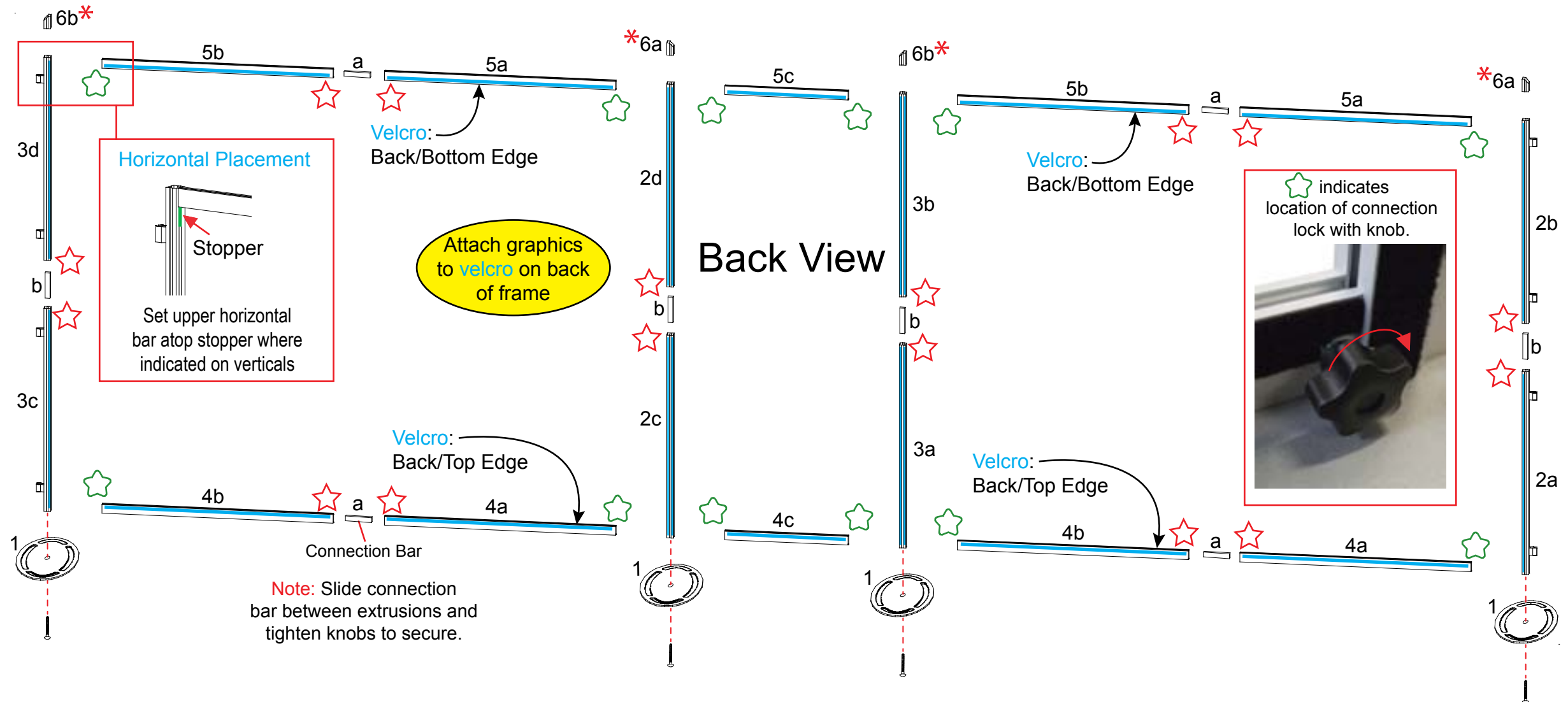
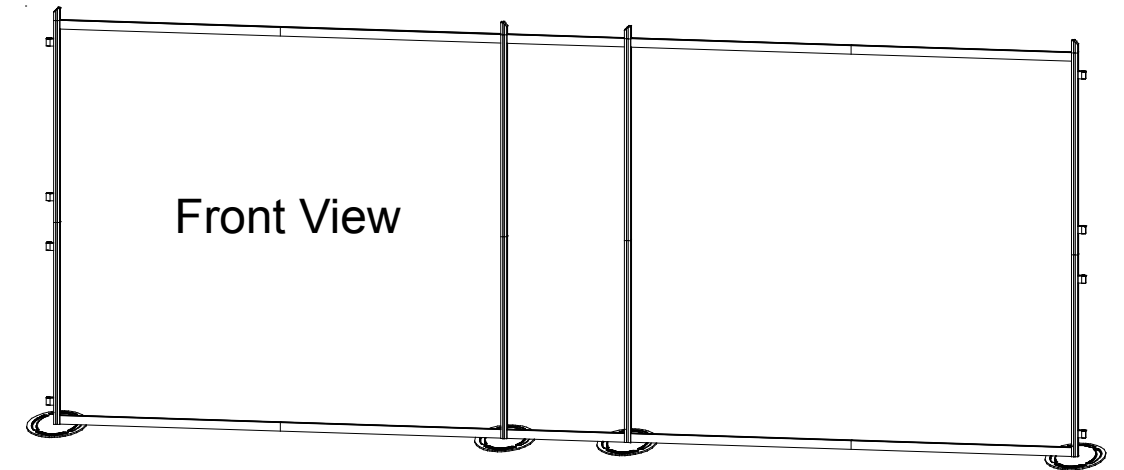
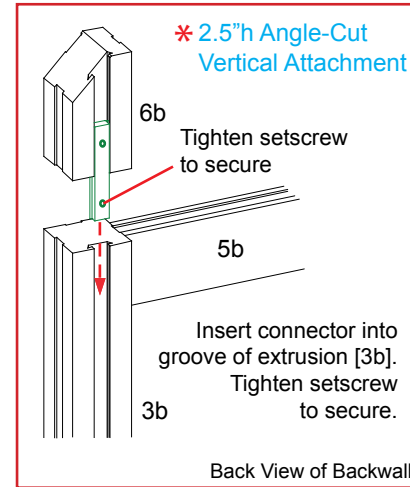

WHEN DISASSEMBLING ALUMINUM EXTRUSION, TIGHTEN ALL SETSCREWS AND LOCKS TO PREVENT LOSS DURING SHIPPING

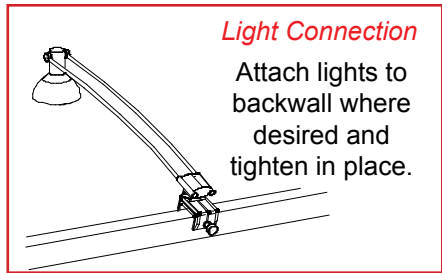

- Steps:
 1) Attach lights as indicated.
 2) Attach wings to A10 clamps as shown.

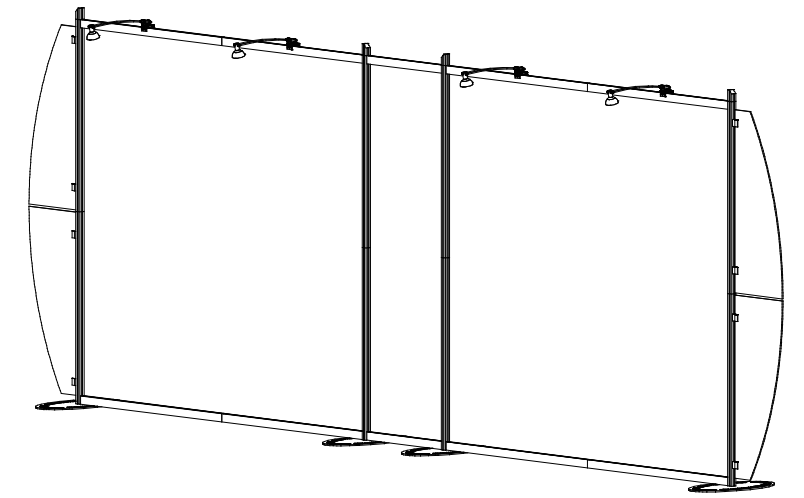

Wing Attachment

Slide A10 Clamp into groove of square extrusion.

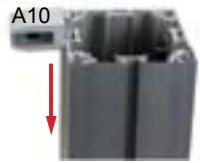

When desired location is found, tighten set screw to secure.

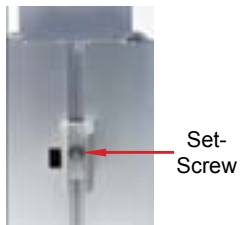

Tighten black plastic set screw to secure Wing in place.

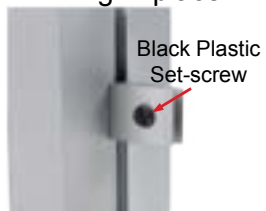

**Note: A10 clamps must stay attached with verticals*

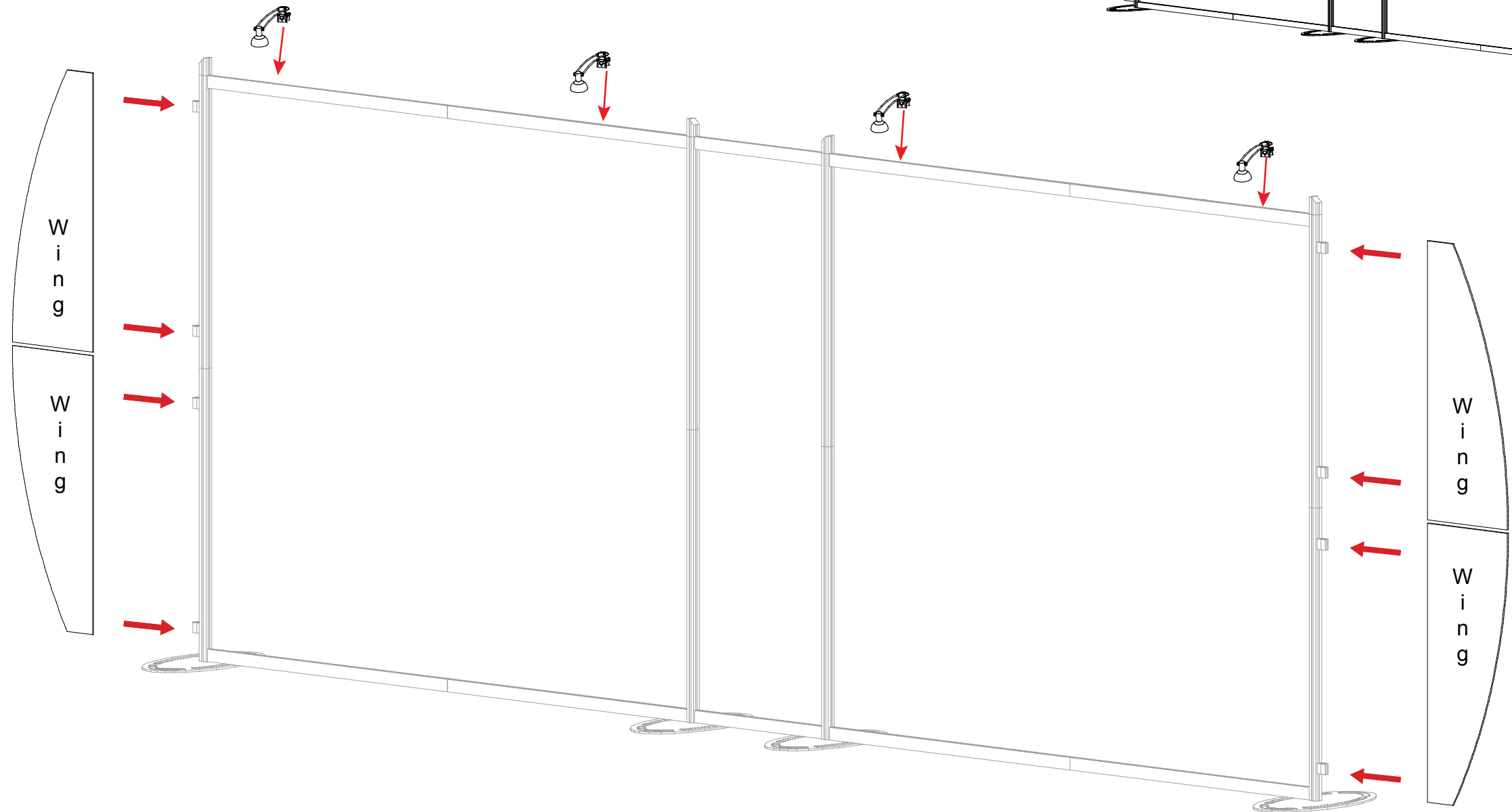

WHEN DISASSEMBLING ALUMINUM EXTRUSION, TIGHTEN ALL SETSCREWS AND LOCKS TO PREVENT LOSS DURING SHIPPING

Top View of each level

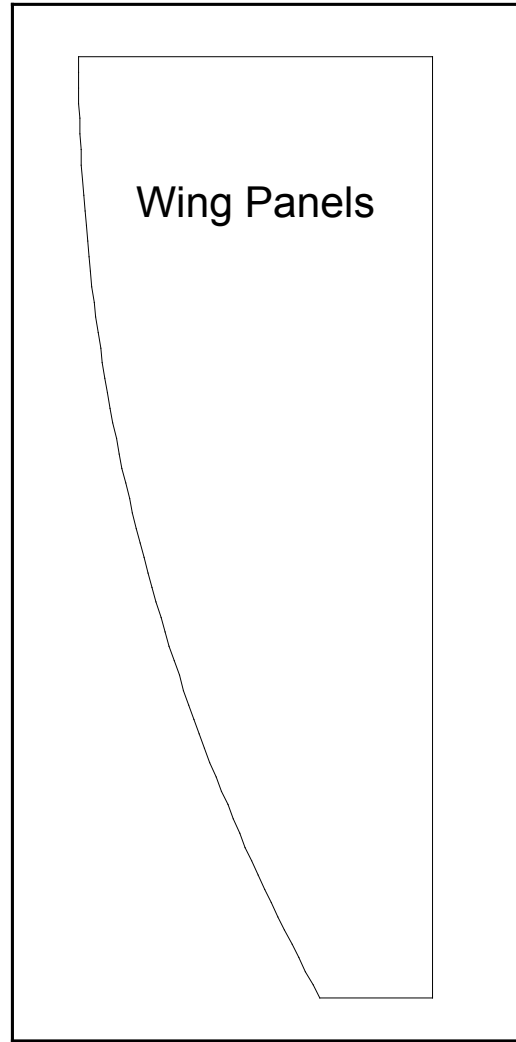

Level 1

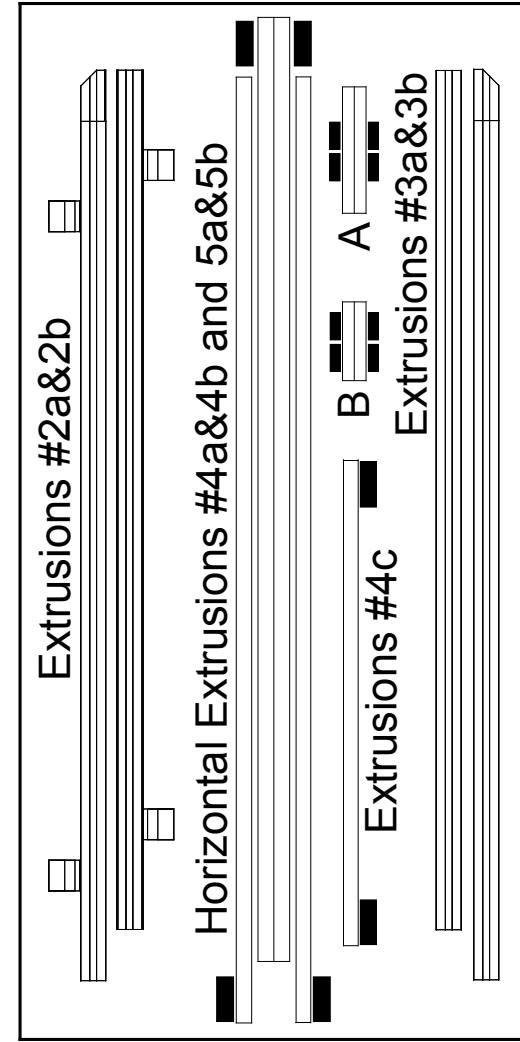

Level 2

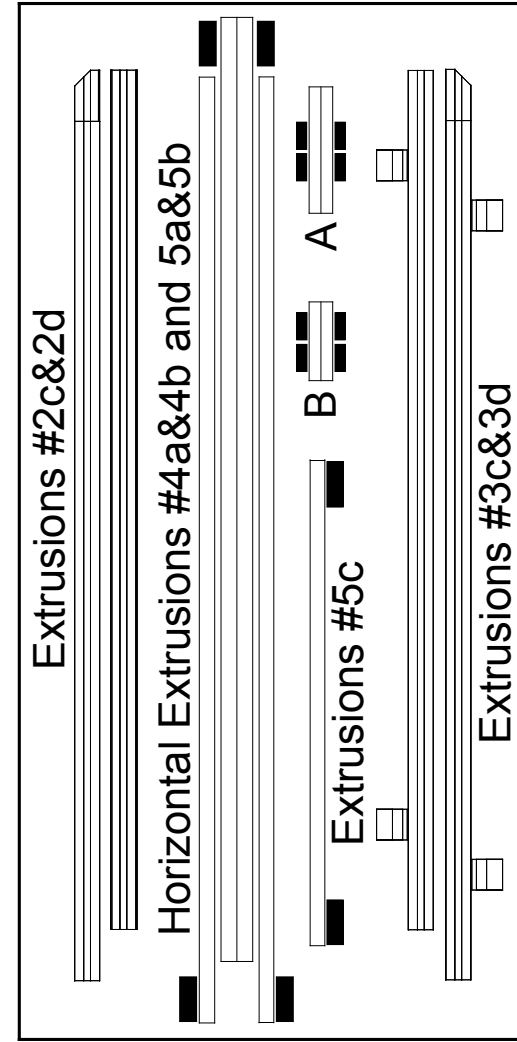

Level 3

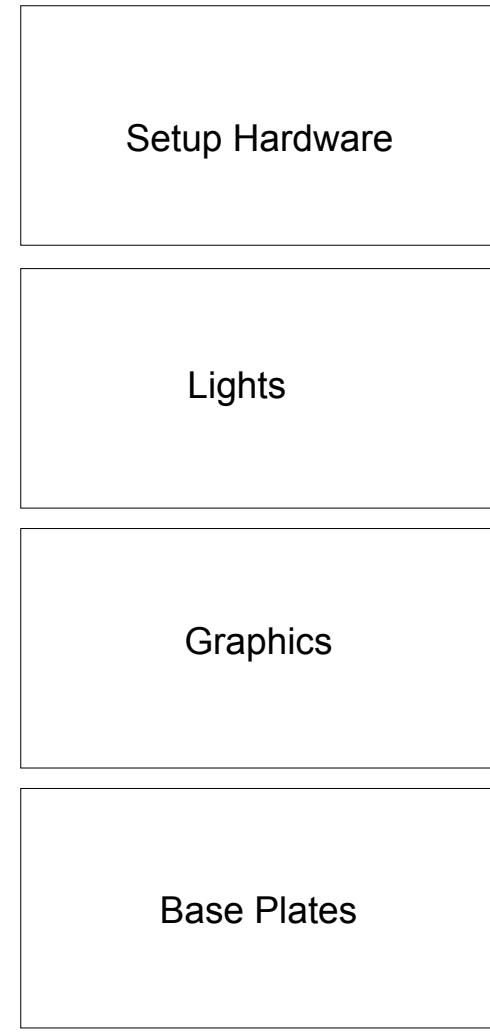

WHEN DISASSEMBLING ALUMINUM EXTRUSION, TIGHTEN ALL SETSCREWS AND LOCKS TO PREVENT LOSS DURING SHIPPING